

EN



INSTALLATION INSTRUCTIONS

INSTALLATION / SERVICING / MAINTENANCE / SAFETY ADVICE



ZODIAC ORIGINAL

ABOVE-GROUND POOL

HIPPO 40 / HIPPO 65

CONTENTS

PLEASE READ CAREFULLY AND KEEP FOR FUTURE REFERENCE

Read this manual carefully to understand all the information and to guarantee safe installation, use and maintenance. We accept no liability for any damage caused by failure to comply with the instructions in this manual.

SAFETY	p. 4
COMPOSITION OF THE KIT	p. 5
Hippo 40	p. 5
Hippo 65.....	p. 6
INFORMATION	p. 7
Advice and warnings.....	p. 8
Choosing a pool location.....	p. 11
Preparing the site and support.....	p. 14
INSTALLATION OF THE POOL	p. 15
Setting up the pool.....	p. 16
Inflation.....	p. 18
Installing the base	p. 20
Filling the pipes.....	p. 21
Filling the pool	p. 23
Warning	p. 24

CONTENTS

Connecting the filter	p. 25
Fitting and installing the floating skimmer	p. 26
STARTING UP AND CLEANING THE POOL	p. 30
ASSEMBLING THE LADDER	p. 32
SAFETY ADVICE	p. 33
RECYCLING	p. 34

SAFETY

These instructions only apply to Zodiac Original pools.
Your accessories such as the ladder and filtration have their own instructions.

⚠ Warning: it is strictly forbidden to use automatic disinfectant production by saltwater electrolysis in Zodiac Original pools.



Electrolysis generates hydrogen, which can concentrate inside the coil. Hydrogen is an explosive gas in the presence of a simple spark.

COMPOSITION OF THE HIPPO 40 KIT

KIT HIPPO 40

Before installing your HIPPO 40 swimming pool, make sure you have all the components in the kit.

Reference	Description	Quantity
P38448	HIPPO 40 Pool	1
P39752	Luxury HIPPO 40 or 65 above-ground pool safety ladder L150	1
P34405	Ø38 mm hose kit (18 m) + Ø38 mm hose valve	1
P36881	Floating Skimmer	1
P34657	OV6 inflation device	1
SAND	25 kg Sandbag	6
P4699	Zodiac Original repair kit	1
A-P20020	Sand filtration plate 16m ³ /h Ø 50 mm pipe	1

Approximate water volume **	100 m ³
Length of body of water	9 m
Width of body of water	5 m
Pool height	1.25 m

PACKAGING *

2 pallets:

- 1.20 x 0.80 x 1.30 m
- 1.83 x 0.83 x 1.84 m

Total weight: 195 kg

ASSEMBLY ***



2 persons



4 hours

* theoretical values - (bare pool)

** theoretical volume of water (pool and casing)

*** approximate time for 2 people. Does not take into account the preparation of the soil or the filling of the pool.

COMPOSITION OF THE HIPPO 65 KIT

KIT HIPPO 65

Before installing your HIPPO 65 swimming pool, make sure you have all the components in the kit.

Reference	Description	Quantity
P38448	HIPPO 65 Pool	1
P39752	Luxury HIPPO 40 or 65 above-ground pool safety ladder L150	1
P38666	ENS,15M Ø 38 mm PIPE + Ø 50 mm FITTINGS	1
P36881	Floating Skimmer	2
P34657	OV6 inflation device	1
SAND	25 kg Sandbag	6
P4699	Zodiac repair kit	1
P39809	SF 622 Filtration unit	1

Approximate water volume**	140 m ³
Length of body of water	13.50 m
Width of body of water	4.6 m
Pool height	1.30 m

PACKAGING *

2 pallets:

- 1.20 x 0.80 x 1.30 m
- 1.83 x 0.83 x 1.84 m

Total weight: 270 kg

ASSEMBLY ***



2 persons



5 hours

* theoretical values - (bare pool)

** theoretical volume of water (pool and skirting)

*** approximate time for 2 people. Does not take into account the preparation of the soil or the filling of the pool.

INFORMATION

Before proceeding with assembly, examine all the parts and identify them according to your model's parts list.

Review all the tools and materials you'll need to install your pond. Buy what you need. All our pools are for outdoor family use. They are designed to be laid on firm (no backfill), stable ground.

Read and follow the safety instructions carefully. Please do not hesitate to contact our authorised distributors for further information. Be careful, your pond contains thousands of litres of water; a poorly prepared floor or a badly assembled pond can cause major damage.

REMINDER:

HIPPO 40: Your pool contains 40 m³ of water in the skirting and 60 m³ of water in the pool itself, i.e. 100 m³ or 100 tonnes.

HIPPO65: Your pool contains 65 m³ of water in the pipes and 75 m³ of water in the pool itself, i.e. 140 m³ or 140 tonnes.



Warning: there are some very specific instructions to be followed: read them carefully and completely before setting up and starting installation work.

Legal obligations: check the current regulations on swimming pool installations (contact your local council).

Your pool must be built according to best practice and standards in force. Consult or have your work carried out by specialist contractors such as diggers, masons, pool builders, plumbers, electricians and others if necessary.

INFORMATION

ADVICE AND WARNINGS

The swimming pool is a place of joy and fun, but it also has risks, particularly for young children who don't know how to swim. Be particularly careful and never leave them unattended.

1. Never leave young children unattended. Never let them swim alone.
2. Do not dive; the water isn't deep enough.
3. Remove the ladder or access to the pool after use.
4. A summer cover, cover or winter cover does not constitute a safety device pursuant to standard NFP 90-308.
5. Teach children to swim as early as possible.
6. Never enter the water suddenly after exposure to the sun or violent exercise, as you risk hydrocution.
7. Only fill the pool with mains water and use maintenance products intended only for swimming pools. Always keep your water clean and chemically balanced.
8. Never allow an animal (dog, cat, etc.) to bathe in the pool, as it could tear the membrane and/or drown.
9. Never use your pool if you have been drinking alcohol or taking drugs. This could result in shock, unconsciousness, a serious accident or drowning.
10. If the pool has an unsecured access (raised terrace, pontoon, other...), you must use a standardised safety device. Contact a specialist dealer.
11. Don't swim after dark when you can't see the bottom. It is your responsibility to provide adequate lighting. Consult your electrician about this type of installation, and check that you are complying with current electrical regulations.

INFORMATION

12. Never cut the membrane to fit a spotlight or any other non-original accessory.
13. Never swim between the pool wall and the ladder (risk of getting stuck).
14. Avoid placing anything around the pool that could be used for climbing or as a diving board. Leave plenty of space around the pool. (At least 1 metre).
15. Never throw heavy objects against the skirting or into the pool.
16. Never use an appliance such as a saltwater chlorinator: risk of explosion of the pool, injury and exclusion of guarantee.
17. Periodically check the condition of your pool and its accessories. Replace any damaged or worn parts. Always use the manufacturer's original parts.

INFORMATION

As the pool is above ground and has no means of access, it does not require a standardised safety device. You can, however, add certain protective equipment such as:

- Standardised protective barrier with gate kept closed at all times
- Electronic passage or fall detector, in service and operational.



WARNING: never use a lawnmower or trimmer (nylon thread) near your pool. A cut could cause permanent damage to the pool. Never allow sharp objects to come into contact with the pool and avoid any violent impact with it. If an electric cable is damaged, do not repair it; have it replaced by an approved electrician.

SAFETY PICTOGRAM: you must affix the following two pictograms within 2 metres of the pool, visible to all (required by standard NF EN 16582):

▶ KEEP CHILDREN UNDER SUPERVISION IN AN AQUATIC ENVIRONMENT



▶ DO NOT DIVE



▶ IN THE EVENT OF DROWNING

- Act very quickly to get the victim out of the water
- Contact the fire brigade 18 and/or SAMU 15
- If you have been trained, practise First Aid

CHOOSING A POOL LOCATION

The following criteria must be considered before choosing the final location:

▶ THE GROUND

Select a location where you can obtain a perfectly level surface with no backfill. Watch out for water ingress.

▶ THE LOCATION

Determine the best location on your land. It must be spacious. Leave enough space around the base of the pool, at least 1 metre.

▶ OVERHEAD POWER LINES

As a precaution, the pool should not be placed directly under overhead power lines. In some departments, this is prohibited by law.

▶ SUNSHINE

If you have access to a number of sunny locations, it's best to choose those that receive the morning sun, which has a much greater calorific value than the late day sun.

▶ WIND

Install the pool somewhere that is sheltered from prevailing winds. A pool exposed to the wind loses a lot of heat through evaporation. Covers (summer bubble covers or winter covers) exposed to too much wind can deteriorate prematurely.

▶ WATER LEVELS

Except in the case of short-term maintenance, or when the pool is taken down for the winter period, it must always be kept at its normal level of use, whatever the season.

▶ TREES

Trees are not always an issue, but they can pose problems in terms of routine maintenance and water pollution.

▶ WATER SUPPLY

The pool is filled with water using a simple garden hose (do not use borehole water). Remember to allow for the possibility of draining your pool for wintering or short-term maintenance. Refer to regulations in force.

▶ UNDERGROUND CONNECTIONS

Make sure that no underground connections (water, gas, electricity, telephone, cables, etc.) run beneath the site of your pool.

▶ THE POWER SUPPLY

Provide a power supply for your filtration system.



**Incorrect installation may result in electric shock or even damage to the appliance.
We recommend you disconnect the power supply before carrying out any work.**

WARNING:

Your filtration system must be located at least 2 metres (IPX5) / 3.5 metres (IPX4) from your pool in accordance with the requirements of the NF C 15-100 installation standard. Seek the manufacturer's advice before modifying one or more elements of the filtration system.

INFORMATION

Electrical risk: Always connect your filtration system to an earthed power supply protected by a 30mA earth leakage circuit breaker. Contact a qualified electrician to check your installation. The filtration system must be connected to an electrical installation that complies with national installation standard NF C 15-100.

The type and cross-section of the electrical cable must be appropriate for your installation. The C15-100 electrical standard requires the use of electrical equipment with double insulation and no metal reinforcement.

For a fixed installation, use a U1000R2V (or RO2V) type cable with a protective sheath or trunking.

For temporary use, a more flexible H07 RNF cable can be used, but under a protective trunking.

The cable cross-section depends on the power consumed by your appliances and the length of cable used. Refer to the table below.

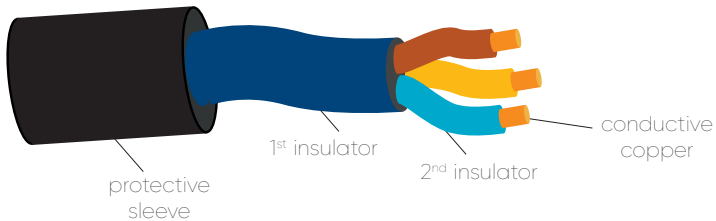

Maximum lengths of copper cable for single-phase 230V supply (2% voltage drop).

cable conductor cross-section

Current (A)	Power (KW)	1.5 mm ²	2.5 mm ²	4 mm ²
2.2	0.5	69 m	115 m	184 m
4.3	1	35 m	58 m	92 m
6.5	1.5	23 m	38 m	61 m
8.7	2	17 m	29 m	46 m
10.9	2.5	14 m	23 m	37 m
13.0	3	12m	19 m	31 m
17.4	4	x	14m	23 m

INFORMATION

PREPARING THE GROUND

The ground on which the pool rests must be flat, firm, stable, smooth and perfectly level. The pool fabric should always be placed on a special rot-proof liner mat (not supplied). Never place the pond on the ground or directly on a cement floor.

PREPARING THE SUPPORT

There are two possible types of support

▶ ON A CONCRETE SLAB

Check with a professional that the permissible load per m² of the slab (existing or future) is sufficient (1 m of water height = 1,000 kg/m²).

You can install your pool after this check and once the ground is clean and level.

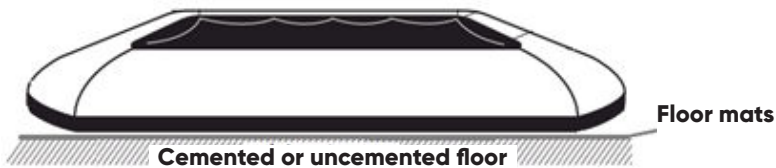

▶ ON NATURAL GROUND (NOT CEMENTED)

Never install your pool directly on ground such as:

- Freshly treated with chemical products such as fertilisers or weedkillers, which can irreparably damage the pocket.
- Gravel / Grass / Wood bark / Sea sand.
- Freshly tarmacked ground.

INSTALLATION OF THE POOL

1. Mark out the floor surface to be prepared. This is equal to the external dimensions of the pool + 10 cm

HIPPO 40: | $X = 11.8 \text{ m} + 10 \text{ cm}$
| $Y = 7.7 \text{ m} + 10 \text{ cm}$

HIPPO 65: | $X = 16.55 \text{ m} + 10 \text{ cm}$
| $Y = 8.25 \text{ m} + 10 \text{ cm}$

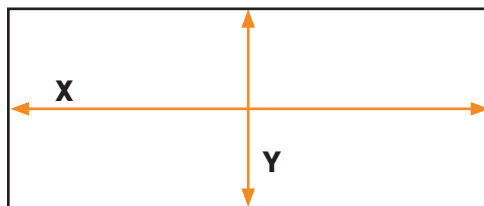

If the land is on a slope, always remove the soil from the top. Never place the pool on backfilled ground. Under the weight of the water, settling will cause stresses that could deform and damage your pool.

If you don't have a laser level, use a long ruler and a spirit level. Find the lowest point of the surface to be prepared and level the ground to the height of this point. Level the ground on the basis of the lowest point once the topsoil has been stripped.

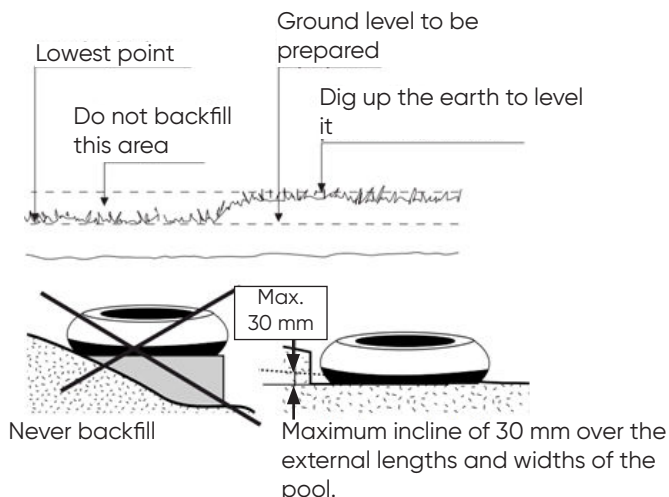

2. Remove vegetation to prevent it from growing back (weeds, roots, etc.) to ensure your pool has a compact support surface and to prevent the grass under it from rotting.

3. It is particularly important for the ground to be stable, compact and free of anything that could damage the pool. To correct any unevenness of the ground, spread and level a layer of screed sand approximately 2 cm thick before installing the floor mat.

INSTALLATION OF THE POOL

SETTING UP THE POOL

1. Never use a box cutter to open the box. Remove the pool in several groups according to weight. Never drag the pool over the ground, whatever its nature. Keep the packing box.

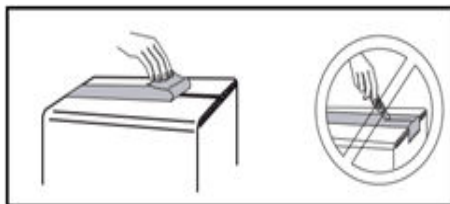

2. Either position the pool (unfolded) at the left end of the prepared surface and to the right of the axis of symmetry. This means that when the tank is unfolded, the drain plug will be on the right-hand side: A of the diagram.

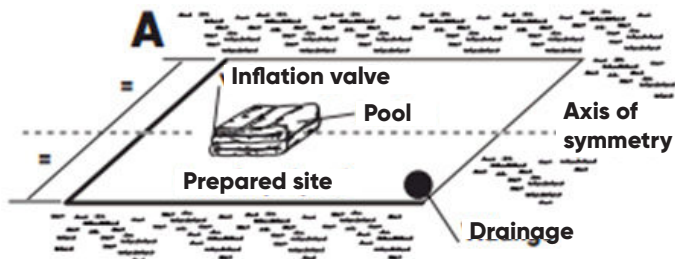

Or position the pool (unfolded) at the right-hand end of the prepared surface and to the left of the axis of symmetry. This means that when the pool is unfolded, the drain plug will be on the left: B of the diagram.

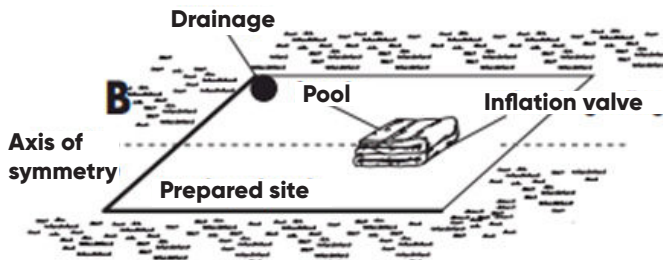

INSTALLATION OF THE POOL

3. Unfold your pool from phase 1 to 10



1

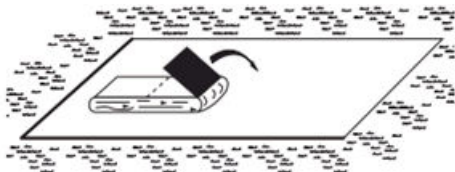

2



3

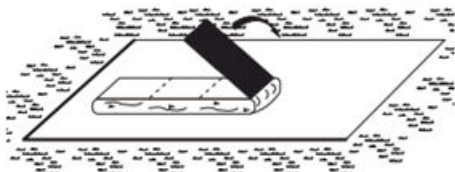

4

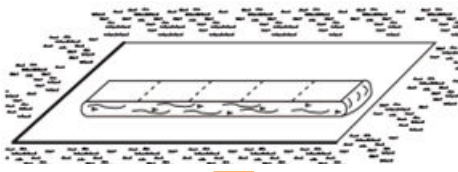

5



6

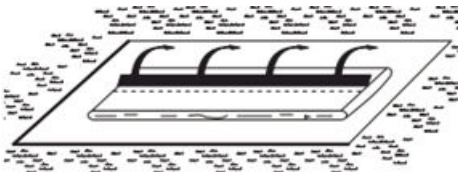

7

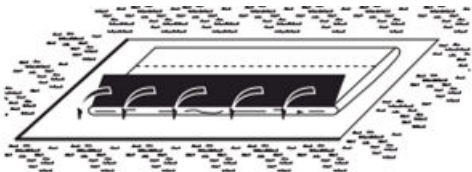

8

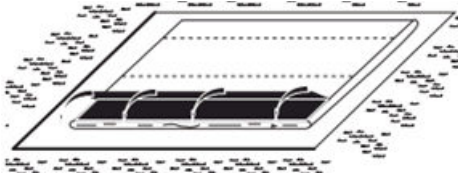

9

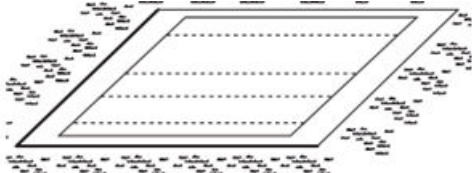

10

! Screw on the filler, drain and vent plugs after removing the protective cover (keep these covers).

INSTALLATION OF THE POOL

INFLATION

1. Unscrew the cap on the non-return valve only, then connect the inflation device to the valve. Inflate the skirting slightly; it should start to take its shape.



Note: The number of the pool is written on the base of the plug.

Detail of the non-return valve plug:



! NEVER USE A COMPRESSOR, OTHERWISE THE POOL MAY BURST AND THE GUARANTEE MAY BE INVALIDATED.

2. Fit the nozzle of the inflation device into the part.
3. Connect the inflation device (220 V AC) and switch it on.

INSTALLATION OF THE POOL

4. Inflate the skirting until the pressure relief valve(s) opens. It opens automatically and can be recognised by a regular "psst" whistle.

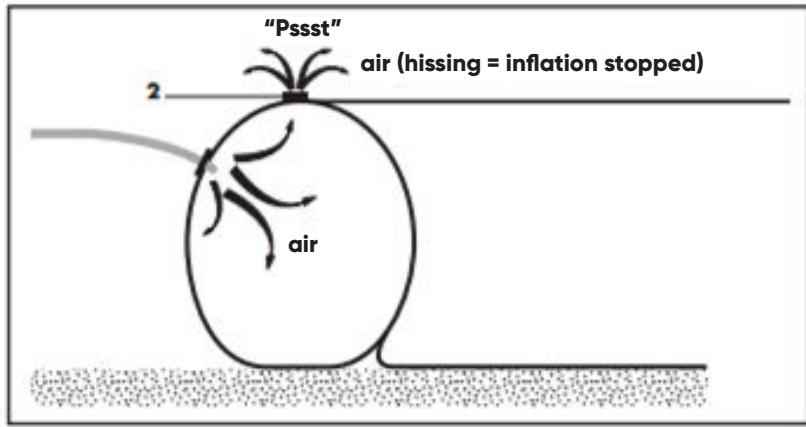

5. Stop the inflation device, remove the nozzle of the device from the water connection.

At this stage, it is still possible to move the basin so that it is well positioned on the prepared surface.

! **Important: the shape and dimensions of the pool are not yet final, even when it is inflated with air. It's height is greater.**

The pool will take on its "final" shape and dimensions once it has been filled with water (the skirting + pool).

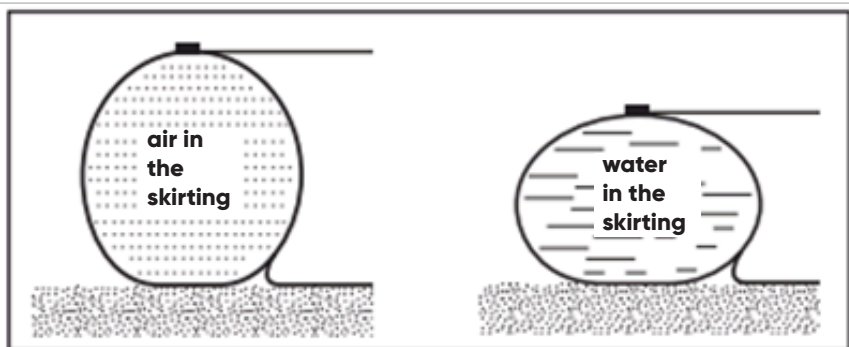

INSTALLATION OF THE POOL

LAYING THE BASE

! Important: This stage is only carried out when the skirting is completely filled with AIR, and you hear the whistling sound.

1. Start filling your pool with mains water. Not spring nor rainwater (cases where the guarantee is excluded).

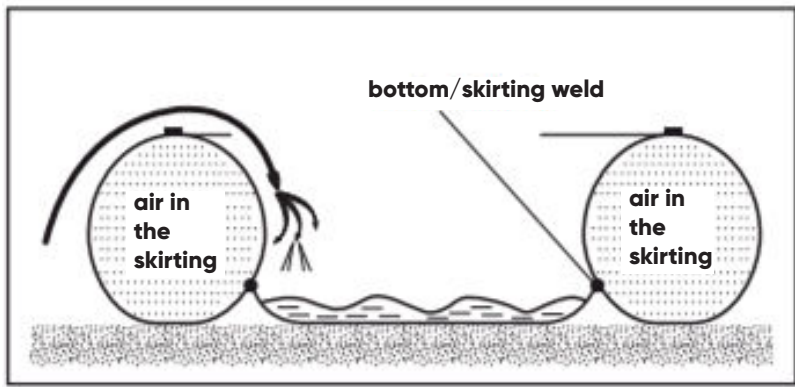

2. Stop filling when the water reaches the top of the bottom/skirting seam. The shape of the pool is not yet final.

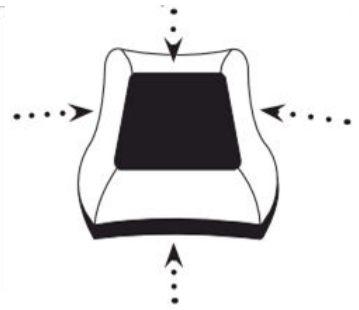
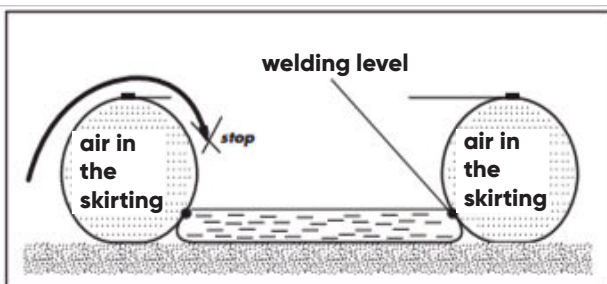

INSTALLATION OF THE POOL

FILLING THE SKIRTING WITH WATER

1. Use a garden hose to fill your pool with water (pool connection nozzle not supplied). You can use the inflator connection
2. Start filling. As the tank is filled, the air is released through the pressure relief valve(s). It is essential to check that this air is evacuated correctly.

Note: if the filling water pressure is particularly low, you can evacuate the air inside the skirting by using the bleed plug to reduce its pressure.

! Remember to close this plug as soon as the pond starts to collapse.

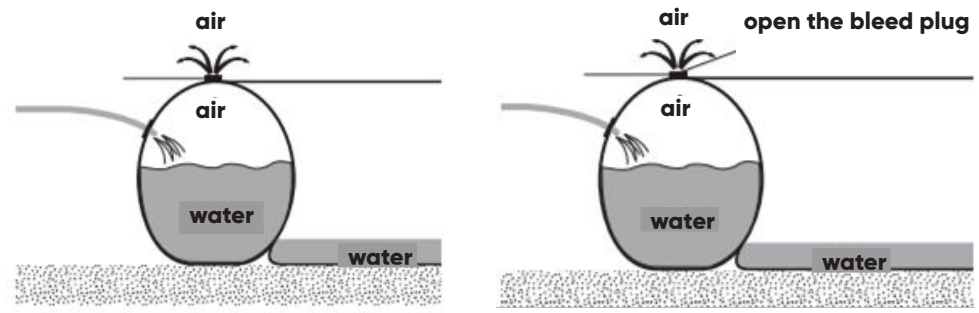

INSTALLATION OF THE POOL

4. The skirting is full of water when it escapes from the pressure relief valve(s). Stop filling and remove the hose.

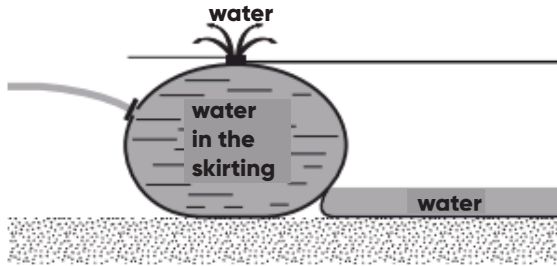

INSTALLATION OF THE POOL

FILLING THE POOL

1. Place the hose in the pool and let it fill up.

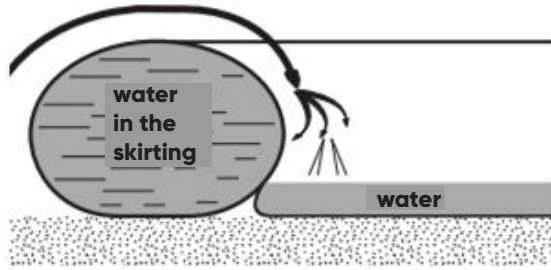

2. Stop filling when the water is level with the rings.

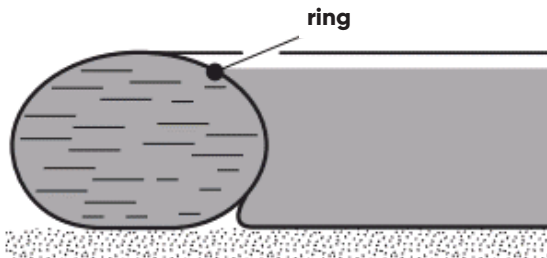

Note: during and after filling your pool, water may seep from the joints and/or the skirting and/or the pressure relief valve(s); this will disappear after a few days.

INSTALLATION OF THE POOL

WARNING

Never carry out any of the following procedures, as you risk irreparable damage to your pool, causing further damage and, above all, endangering the safety of people and property.

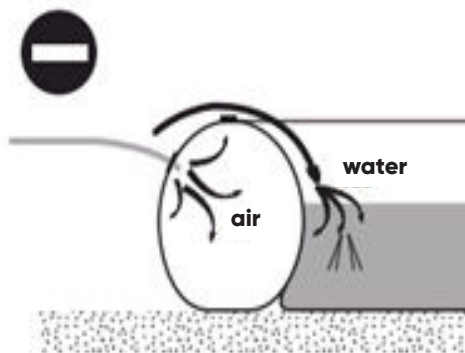

Inflate the air skirting at the same time as filling the pool with water (exclusion of guarantee).

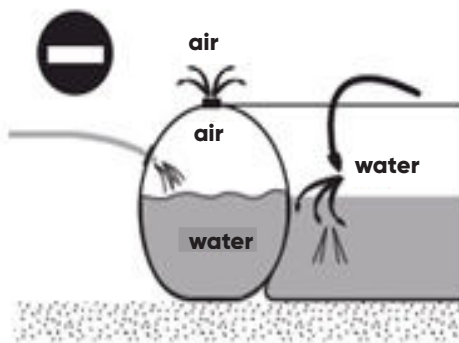

Inflate the water skirting at the same time as filling the pool with water, while the air skirting is not yet fully inflated (exclusion of guarantee).

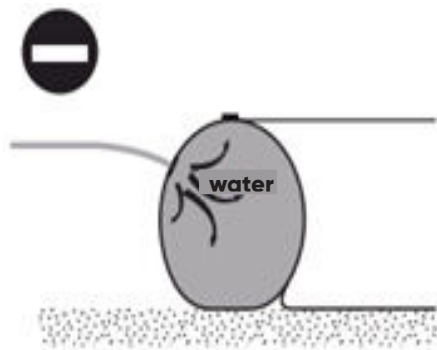

Fill the skirting directly with water without inflating it with air. (exclusion of guarantee).

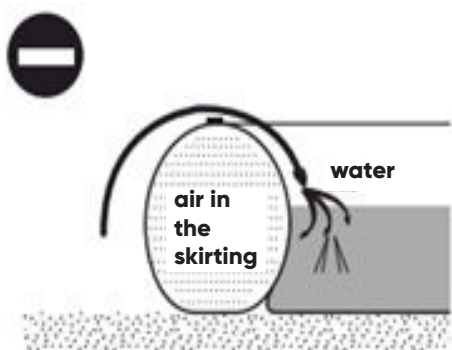

Fill the pool with water using air-filled skirting (exclusion of guarantee). And any other way of installing the pool not described in these instructions.

INSTALLATION OF THE POOL

CONNECTING THE FILTER

To assemble the sand filter, refer to the instructions supplied with it.

Choose a dry location with good drainage, accessible for cleaning the pump and access to the valve. Choose a shady spot (natural or artificial) to avoid overheating the motor. Install the unit on a rigid, flat, level surface. For safety reasons, filtration must be installed at a minimum distance of 3.50 m from the pool. If the distance is greater, contact your distributor to discuss possible solutions.

! We recommend disconnecting the system from the mains before carrying out any work.

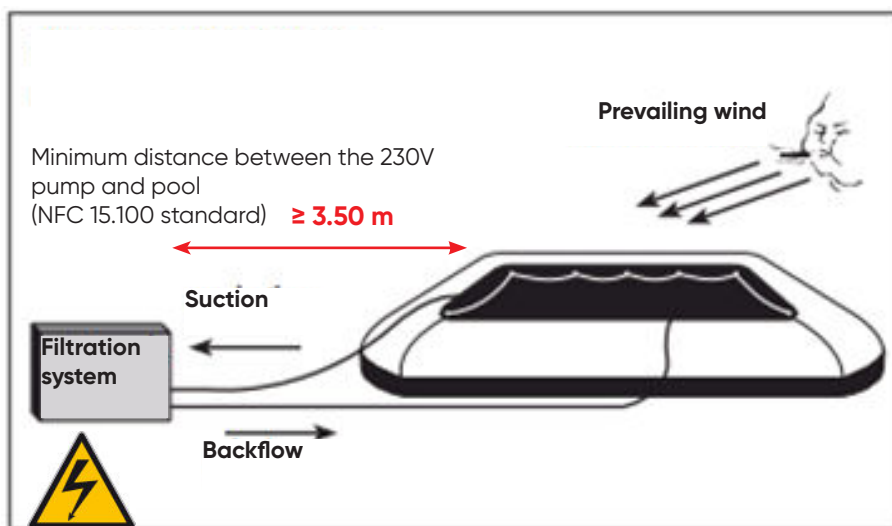

Note: Clamps will facilitate installation.

You must use a socket fitted with a 30mA differential circuit breaker. **More details on pages 12 and 13 of this leaflet.** Consult a specialist about standards in force.

INSTALLATION OF THE POOL

FITTING AND INSTALLING THE FLOATING SKIMMER

COMPOSITION OF THE FLOATING SKIMMER KIT

No.	Designation	Quantity	Reference
1	Base	1	P60992
3	Arm	3	A-P60993
3	Upper cup	1	P60994
4	Ballast	1	P19385
5	Body	1	P19263
6	Barbed connector	1	P60999
7	Float	1	P19262
8	Pre-filter basket	1	P17817
9	Brush hose	-	not supplied
10	Flange	1	P19386
11	Brush holder	1	P17818

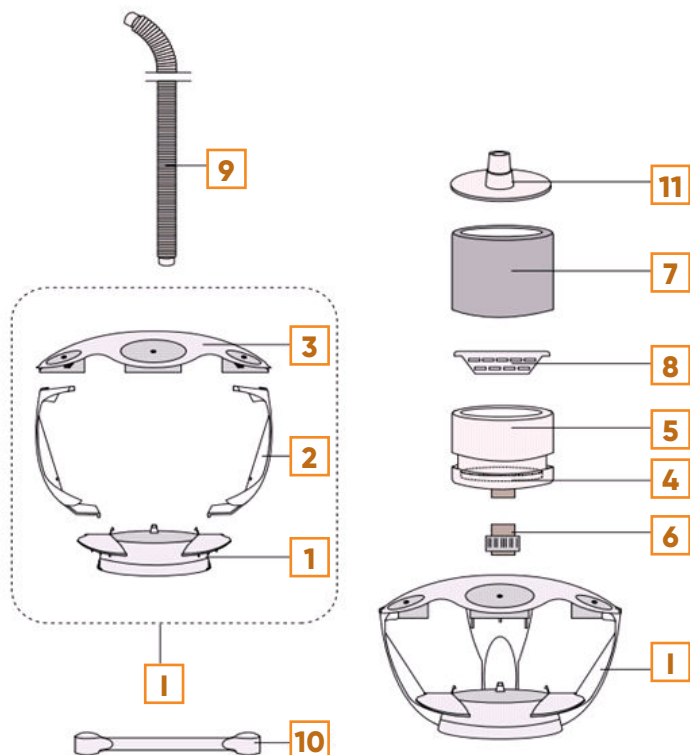

INSTALLATION OF THE POOL

ASSEMBLING THE SKIMMER

Note: a skimmer should always be positioned facing the prevailing wind, which will carry dirt back into the floating skimmer.

1. Connect the arms to the base. Clip (a) goes into opening (A) and clip (b) into opening (B).

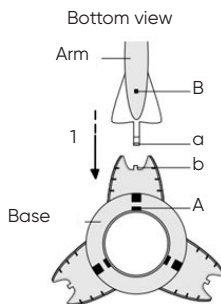
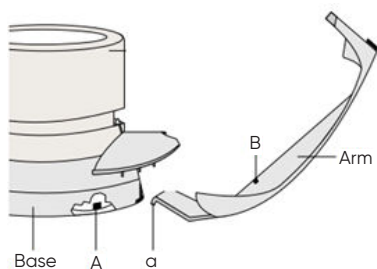

2. Connect the arms to the upper cup. Clip (c) goes into opening (C) and clip (d) into opening (D). Repeat for the other two arms.

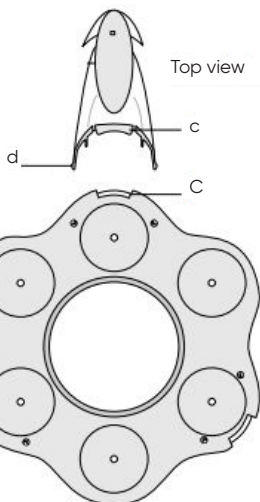
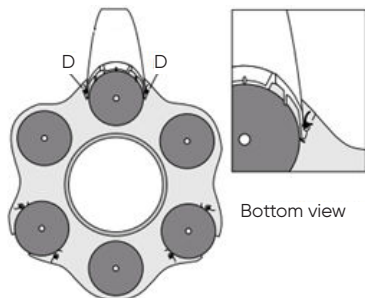
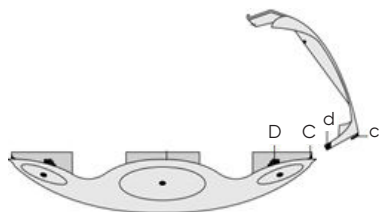

Note: check that the clips (d) are properly engaged in the notches (D).

INSTALLATION OF THE POOL

3. Place the ballast in the body of the skimmer and screw the barbed connector to the skimmer outlet.

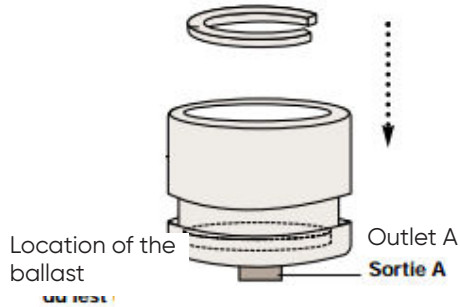

4. Check that the body is properly engaged in the float unit, place the pre-filter basket in the body, then place the float on the body.

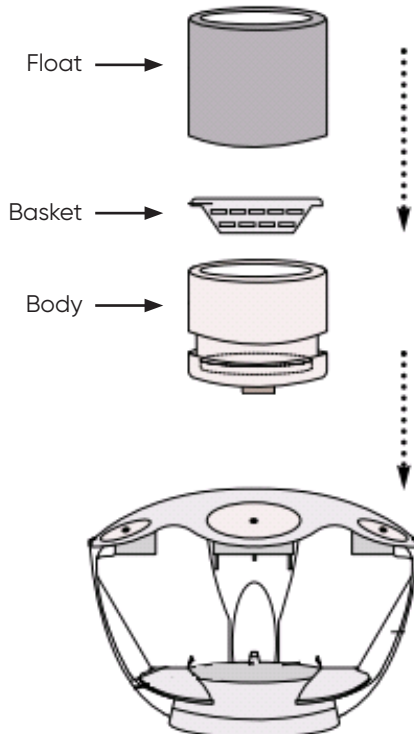

INSTALLATION OF THE POOL

▶ INSTALLING THE FLOATING SKIMMER

Connect the hose from your filtration system to the hose barb. Slide the flange over the connecting pipe so that the skimmer is perpendicular to the water.

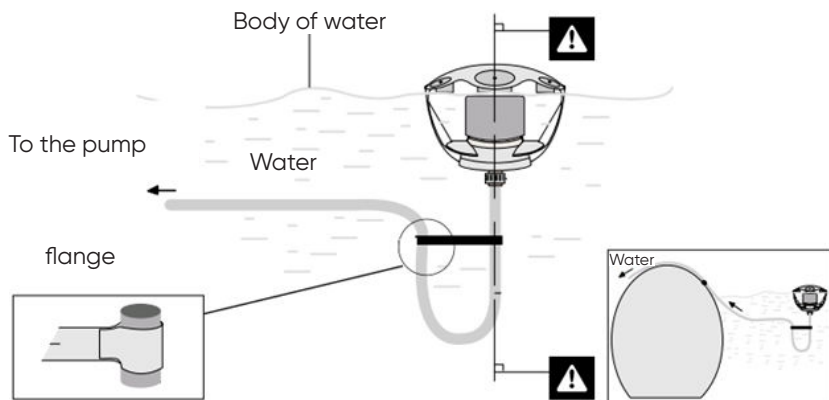

As it floats freely on the water, this floating skimmer has the advantage of automatically adjusting itself in relation to the body of water.

Diagram 1 shows the path of the water flow when the filtration system is in operation.

If, for any reason, the skimmer becomes disconnected while the filtration system is operating (diagram 2), the body will lift up by suction, allowing water to pass through the openings (diagram 3). This system prevents the filtration system from becoming disconnected. The skimmer is reconnected automatically. If this is not the case, check that the float slides correctly over the body (diagram 4).

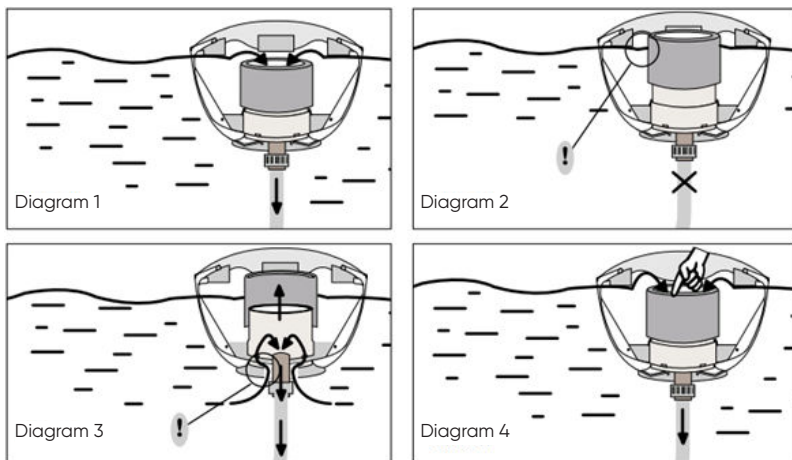

STARTING UP AND CLEANING THE POOL

START-UP

To start up your filtration system, refer to the filtration manual. It can even be used while swimming.

It is sometimes possible for the skimmer to become disconnected when there is a lot of movement on the surface of the water.

Important: To prime the pump:

- Stop filtration.
- Place the skimmer on top of the skirting.
- Partially unscrew the pre-filter cover from the pump.
- Fill the hose from the skimmer using a garden hose.
- When the water escapes through the pump's pre-filter cover, close the cover again.
- Return the skimmer to the water.
- Then start the filtration system.
- Under no circumstances should chlorine (powder or pebbles) be thrown directly into the pool or skimmer, as this will discolour the bag and damage the filtration.
- When the pool is not in use, use a chlorine float (not supplied) to distribute the chlorine pebbles slowly and evenly (make sure the cover is closed).

STARTING UP AND CLEANING THE POOL

CLEANING THE POOL WITH A HOOVER

Place the head of the Hoover on the telescopic handle.

Place one end of the vacuum hose on the broom head and the other on the broom socket plate.

** Not supplied with floating skimmer*

Before fitting the brush connector to the skimmer float, make sure there are no more air bubbles in the brush or robot pipes. To do this, prime the hose, with the Hoover brush already at the bottom, by filling the hose completely with water.

With the filtration system running, place the brush plate on the skimmer, avoiding any ingress of air.

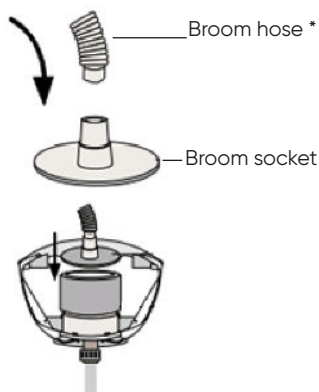

ASSEMBLING THE LADDER

Refer to the assembly instructions for your ladder for instructions on how to assemble it.

Only place the ladder when the pool is fully installed and in water. Avoid the ladder touching the pool (friction could damage the fabric of the pool).

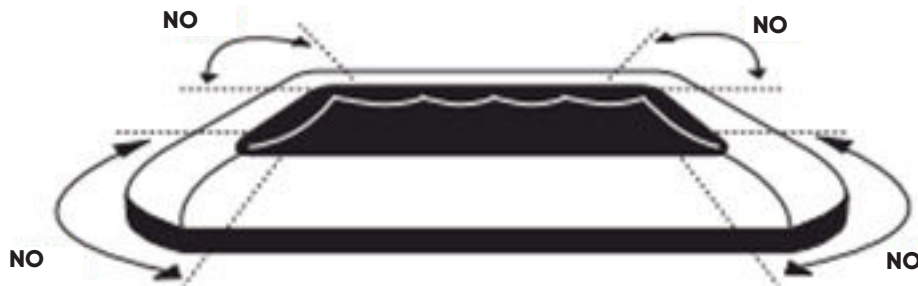

For semi-embedded pools, the ladder needs to be adjusted on site (by partially burying it) to suit the desired height.

Warning:

- **If the pool is not properly filled with water and the bladder filled with air, there is a risk of the ladder rubbing against it.**

Reminder:

- **For safety reasons, remove the ladder when the pool is not in use if it does not have retractable steps.**
- **A visible marking in the position of use, reminding the user that the external climbing surface must be removed, retracted or raised after use, must be installed at each means of access.**

Our standard ladders are made from stainless steel tubing. There are no precise rules about how or when they should be maintained.

A visual check is necessary during and after each season. Any rust spots should be remedied by applying anti-rust paint. The precautions to be taken are generally indicated on the container.

Staircases installed in a pool area with a depth of 1300 mm or more must have a minimum of 3 internal steps, outside the edge and at the bottom of the pool.

SAFETY ADVICE

Please read the recommendations set out below with care.

WARNING

Swimming pools can represent a serious danger for your children. Drowning can happen very quickly.

Children who are close to a swimming pool need to be watched constantly and actively, even if they know how to swim.

Learn lifesaving skills.

The physical presence of an adult is absolutely essential whenever the pool is open.



Memorise the telephone numbers for the emergency services and ensure that they are displayed close to the pool.

☎ 18 (in France) or 112

FIRE SERVICE

☎ 15

**AMBULANCE
SERVICE**

(write the number that applies in your region)



POISON CONTROL

CENTRE

RECYCLING

PACKAGING

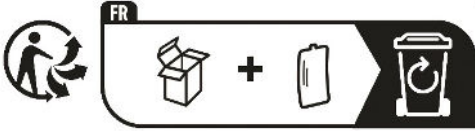

Dispose of the packaging in line with current rules and regulations.

END OF LIFECYCLE



- Do not put your scrapped equipment or used batteries in with unsorted household waste.
- You are responsible for disposing of all of your waste, in particular electrical and electronic equipment by taking it to a collection point where recycling and valorisation are carried out.
- Certain products potentially contain substances that are dangerous for the environment, and you need to ensure that these are eliminated or neutralised.
- Make sure that you are aware of all existing recovery and collection systems.



discard the manual in line with the current regulations.

DEL SAS
17 R COLONEL BOUVET
68530 BUHL - FRANCE

☎ +33 (0)9 70 72 5000 / INFO.FR@CF.GROUP

STAMP

Zodiac Original,
A brand by



ORIGINAL INSTRUCTIONS

/ 2023.11

A-DOTE/2009LI